

ACCESSORIES

Product Assortment



Non-system







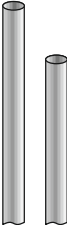
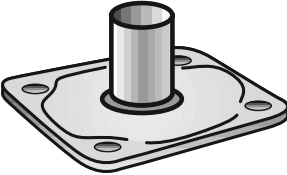
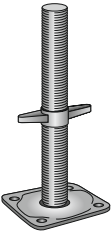
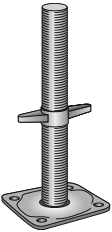
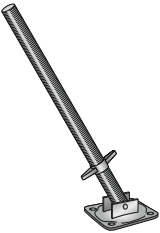
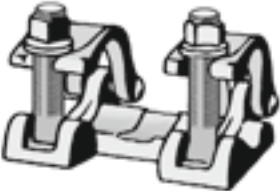

TABLE OF CONTENTS

CATEGORY	SUBJECT	PAGE
1	Tubes and base jacks	4
2	Couplers	5-7
3	Castors	8
4	Lattice girders	9-10
5	Lattice girders and triangular column	11
6	Ladders and accessories	12
7	Aluminium beams	13
8	Aluminium planks	14
9	Timber planks	15-16
10	Ratchet spanners and work aids	17-18
11	Mounting material	19-20
12	Tarpaulins, nets and keder systems	21-23
13	Pallets and storage	24-25
14	Site safety equipment	26-27
15	Work safety	28-29







Tubes and base jacks









		↑ m	↔ m	↗ m	kg/1	ART	€/1
	EN	STEEL SCAFFOLD TUBE 1 1/2, 3.25 MM WALL THICKNESS"	1.000		3.400	07070	
			2.000		6.800	07072	
	DE	STAHL-GERÜSTROHR 1 1/2" 3,25 MM WANDSTÄRKE	4.000		13.600	07076	
			5.000		17.000	07078	
			6.000		20.400	07080	
						Larger quantities upon request	
	EN	STEEL TUBE 1 1/2" 4.05 MM WALL THICKNESS	6.000			00270	
	DE	STAHL-GERÜSTROHR 1 1/2" 4,05 MM WANDSTÄRKE					
						Price and delivery time on demand	
	EN	ALUMINIUM TUBE 1 1/2" 4.00 MM WALL THICKNESS	6.000		8.400	00959	
	DE	ALU-GERÜSTROHR 1 1/2" 4,00 MM WANDSTÄRKE					
						Other sizes and larger quantities upon request	
	EN	BASE PLATE			1.200	00378	
	DE	FUßPLATTE					
	EN	BASE JACK Ø 38 MM		0.300	2.400	00357	
	DE	GEWINDEFUßPLATTE Ø 38 MM		0.500	3.200	E02AA0341	
				0.780	4.200	E02AA0342	
				1.000	4.700	E02AA0343	
				0.600	3.900	08358	
	EN	THREADED BASE PLATE Ø 32 MM		0.500	3.000	00356	
	DE	GEWINDEFUßPLATTE Ø 32 MM		0.780	3.900	00359	
						Special prices see price list non-system accessories	
	EN	HINGED, ADJUSTABLE BASE JACK Ø 38 MM		0.500	3.100	E02AA0357	
	DE	GEWINDEFUßPLATTE, SCHWENKBAR Ø 38 MM					

Couplers





		⇅ m	↔ m	↻ m	KG/1	ART	€/1
	EN STANDARD BB COUPLER DE NORMALKUPPLUNG BB	SW 19 SW 22			1.300 1.300	04963 04962	
Couplers with stamped name on it, for order volume of more than 5000 pieces of one sort, price on demand.							
	EN STANDARD BB COUPLER DE NORMALKUPPLUNG BB MIT FEUERVERZINKTER SCHNELLSCHRAUBE	SW 19 SW 22			1.300 1.300	04963S 04962S	
Couplers with stamped name on it, for order volume of more than 5000 pieces of one sort, price on demand.							
	EN SWIVEL COUPLER B DE DREHKUPPLUNG B	SW 19 SW 22			1.400 1.400	04960 04961	
Couplers with stamped name on it, for order volume of more than 5000 pieces of one sort, price on demand.							
	EN SWIVEL COUPLER B WITH HOT-DIP GALVANIZED HIGH-SPEED BOLT DE DREHKUPPLUNG B MIT FEUERVERZINKTER SCHNELLSCHRAUBE	SW 19 SW 22			1.400 1.400	04960S 04961S	
Couplers with stamped name on it, for order volume of more than 5000 pieces of one sort, price on demand.							
	EN TENSION COUPLER DE ZUGKUPPLUNG	SW 19 SW 22			1.600 1.600	00494 00492	
Couplers with stamped name on it, for order volume of more than 5000 pieces of one sort, price on demand.							
	EN TUBE CONNECTOR DE ROHRVERBINDER				1.000	E04AA0220	
	EN HALF-COUPLER DE HALBKUPPLUNG	SW 19 SW 22			0.700 0.700	E04AA0222 E04AA0221	

Couplers





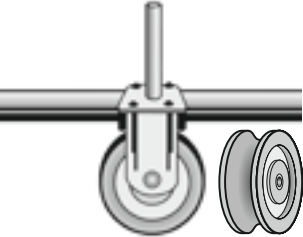

		↕ m	↔ m	↗ m	kg/1	ART	€/1
	EN SHORE COUPLER DE ABSTEIFKUPPLUNG	SW 19 SW 22			1.100 1.100	E04AA0275 E04AA0276	
	EN CARRIER COUPLER DE TRÄGERKUPPLUNG	SW 19 SW 22			1.100 1.100	E04AA0283 E04AA0284	
	EN GRAVITY LOCK COUPLER DE KIPPSTIFTKUPPLUNG	SW 19 SW 22			0.800 0.800	E04AA0273 E04AA0274	
	EN LATTICE GIRDER COUPLER DE GITTERTRÄGER-KUPPLUNG				1.600	E04RS0559	Please indicate width across the flat.
	EN SQUARE TIMBER COUPLER, SWIVABLE DE KANTHOLZKUPPLUNG, DREHBAR	SW 19 SW 22			2.000 2.000	E04AA0227 E04AA0226	
	EN PARALLEL COUPLER DE PARALLELKUPPLUNG	SW 19 SW 22			1.900 1.900	E04AA0217 E04AA0216	
	EN SCREW-ON COUPLER DE ANSCHRAUBKUPPLUNG	SW 19 SW 22			0.700 0.700	00464 E04AA0214	

		↕ m	↔ m	↻ m	KG/1	ART	€/1
	EN STANDARD REDUCTION COUPLER	SW 19	For tube Ø 48x34 mm		1.100	E04AA0387	
	DE REDUZIER-NORMALKUPPLUNG	SW 19	For tube Ø 48x38 mm		1.100	00107	
		SW 19	For tube Ø 48x42 mm		1.100	00108	
		SW 19	For tube Ø 48x60 mm		1.200	00109	
		SW 19	For tube Ø 48x76 mm		1.900	00111	
Delivery time and other dimensions on demand							
	EN SWIVEL COUPLER WITH REDUCTION PIECE	SW 19	For tube Ø 48x34 mm		1.100	00138	
	DE REDUZIER-DREHKUPPLUNG	SW 19	For tube Ø 48x38 mm		1.100	00139	
		SW 19	For tube Ø 48x42 mm		1.100	00140	
		SW 19	For tube Ø 48x60 mm		1.700	00141	
		SW 19	For tube Ø 48x76 mm		1.800	00142	
Delivery time on demand							
	EN SPARE PARTS FOR COUPLINGS, COVER GALVANIZED					05330	
	DE ERSATZTEILE FÜR KUPPLUNGEN, DECKEL VERZINKT						
	EN SPARE PARTS FOR COUPLINGS, CENTRE PIECE, CRUDE PERFORATED					05329	
	DE ERSATZTEILE FÜR KUPPLUNGEN, MITTELSTÜCK, ROH MIT LOCH						
	EN SPARE PARTS FOR COUPLINGS, RIVET					05331	
	DE ERSATZTEILE FÜR KUPPLUNGEN, NIETE						
	EN T-BOLT - METRIC				0.090	00433	
	DE HAMMERKOPFSCHRAUBE - METRISCH						
	EN COLLAR NUT - METRIC				0.030	00430	
	DE BUNDMUTTER - METRISCH				0.040	00431	
	EN T-BOLT WITH HOT-DIP GALVANISED HIGH-SPEED THREAD				0.090	0704ES	
	DE HAMMERKOPFSCHRAUBE MIT FEUER-VERZINKTEM SCHNELLGEWINDE						
	EN COLLAR NUT WITH HOT-DIP GALVANISED HIGH-SPEED THREAD				0.030	07040ES	
	DE BUNDMUTTER MIT FEUER-VERZINKTEM SCHNELLGEWINDE				0.030	07041ES	

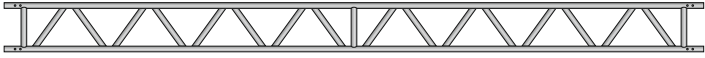

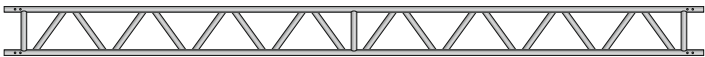



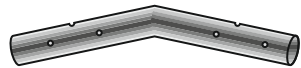

Castors

		⇕ m	⇔ m	↻ m	kg/1	ART	€/1
	EN CASTOR				7.000	E04AA0124	
	DE LENKROLLE						
	EN STEERING CASTOR 12.5 KN (1250 KP) PERMISSIBLE LOAD			0.320	14.900	E04AA0449	
	DE LENKROLLE 12,5 KN (1250 KP) ZUL. LAST						
	EN CASTOR 7.5 KN (750 KP) PERMISSIBLE LOAD			0.260	6.600	00392	
	DE BOCKROLLE 7,5 KN (750 KP) ZUL. LAST						
	EN FLANGE WHEEL				12.800	04676	
	DE SPURKRANZROLLE						
	EN UNIVERSAL MOBILE BASE UNIT		2.000		23.200	E04SR0177	
	DE UNIVERSAL-FAHRBALKEN						

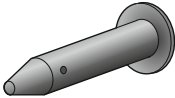

Lattice girder

	↑ m	↔ m	↘ m	KG/1		ART	€/1
EN ALUMINIUM LATTICE GIRDER 450 DE ALU-GITTERTRÄGER 450 	3.200		0.450	13.000	10	00982	
	4.200		0.450	17.000	10	00983	
	5.200		0.450	21.000	10	00984	
	6.200		0.450	25.000	10	00985	
	8.200		0.450	33.000	10	00986	
EN ALUMINIUM LATTICE GIRDER 1000 DE ALU-GITTERTRÄGER 1000 	3.200		1.050	16.700	10	07115	
	4.200		1.050	21.900	10	07116	
	5.200		1.050	25.900	10	07117	
	6.200		1.050	30.800	10	07118	
EN STEEL LATTICE GIRDER 450 DE STAHL-GITTERTRÄGER 450 	3.200		0.450	30.000	10	00632	
	4.200		4.500	37.000	10	00633	
	5.200		0.450	48.000	10	00634	
	6.200		0.450	61.000	10	00635	
	7.300		4.500	70.000	10	00636	
	7.800		0.450	75.000	10	00637	
EN STEEL LATTICE GIRDER 750 DE STAHL-GITTERTRÄGER 750 	2.000		0.750	27.000	10	E04AA0295	
	3.000		0.750	31.000	10	E04AA0144	
	4.000		0.750	42.000	10	E04AA0296	
	5.000		0.750	50.000	10	E04AA0147	
	6.000		0.750	60.000	10	E04AA0145	
	7.000		0.750	69.000	10	E04AA0297	
	7.500		0.750	75.000	10	E04AA0146	
EN STEEL LATTICE GIRDER 1000 DE STAHL-GITTERTRÄGER 1000 	1.630		1.050	33.000		01492	
	2.260		1.050	35.000		01494	
	2.870		1.050	51.000		01495	
	4.120		1.050	62.000		01497	
	5.360		1.050	83.000		01499	
 EN BERLIN LATTICE GIRDER DE BERLINER GITTERTRÄGER	2.000		26.100	16.800		00816	
	3.000		26.100	25.200		00817	
	5.000		26.100	42.000		00819	
 EN TUBE CONNECTOR FOR LATTICE GIRDER, 3.25 MM WALL THICKNESS, STRAIGHT DE ROHRVERBINDER FÜR GITTERTRÄGER 3,25 MM WANDSTÄRKE, GERADE				1.800		00615	
 EN TUBE CONNECTOR FOR LATTICE GIRDER, 3.25 MM WALL THICKNESS, CURVED, SHOT DE ROHRVERBINDER FÜR GITTERTRÄGER 3,25 MM WANDSTÄRKE, GEBOGEN KURZ				2.000		00616	
EN TUBE CONNECTOR FOR LATTICE GIRDER, 3.25 MM WALL THICKNESS, CURVED, LONG DE ROHRVERBINDER FÜR GITTERTRÄGER 3,25 MM WANDSTÄRKE, GEBOGEN LANG				2.400		E04AA0290	

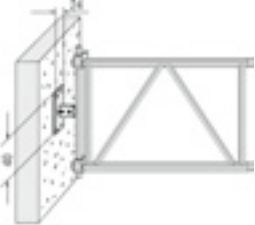
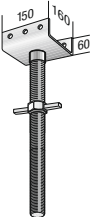

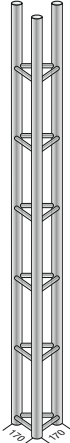

Lattice girder

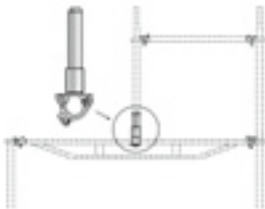
		↑ m	↔ m	↗ m	kg/1	ART	€/1
	EN TUBE CONNECTOR FOR ALUMINIUM LATTICE GIRDERS 4.00 MM DE ROHRVERBINDER FÜR ALU-GITTERTRÄGER 4,00 MM WANDSTÄRKE				1.800	00618	
	EN TUBE CONNECTOR FOR HEAVY-DUTY LATTICE GIRDER DE ROHRVERBINDER FÜR SCHWERLAST-GITTERTRÄGER					06206	
	EN TUBE CONNECTOR FOR LATTICE GIRDER, 3.25 MM WALL THICKNESS, CURVED, LONG DE ROHRVERBINDER FÜR GITTERTRÄGER 3,60 MM WANDSTRÄKE				2.500	E04AA0282	
	EN HEXAGON STEEL SCREW M 12 X 60 MM, 8.8 INCLUDING NUT FOR STRAIR CLIP. DE SECHSKANT-STAHLSCHRAUBE M12 60 MM, 8.8 INKL. MUTTER	0.060				100	E04AA0356
	EN INSERT PIN DE STECKVERBINDER						
	Insert pin, Steckverbinder	0.073	0.012		0.070		00813
	Washer, Unterlegscheibe	0.024	0.003		0.006		00814
	Cotter pin, Federstecker	0.075	0.003		0.012		00815
	Complete, Komplet	0.075	0.073		0.088		E04AA0357
	EN ADAPTER FOR VERTICAL FRAMES ON LATTICE GIRDER BRIDGES DE ADAPTER FÜR VERTIKALRAHMEN AUF GITTERTRÄGER-BRÜCKEN				5.900	00638	
	EN UNIVERSAL WALL CONNECTOR PLATE FOR LATTICE GIRDERS, Ø 20 MM DRILL HOLE DE WANDANSCHLUSSPLATTE FÜR GITTERTRÄGER, Ø 20 MM BOHRUNG	1.200			15.600	E04AA0299	
	EN U-HEAD JACK DE KOPFSPINDEL MIT U-PROFIL			0.550	5.800	00363	

Lattice girder and triangular column

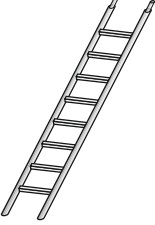
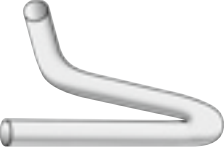





		↑ m	↔ m	↖ m	KG/1	ART	€/1
	EN TRIANGULAR COLUMN	3.000			35.000	E04AA0358	
	DE DREIECKSTÜTZE	4.000			47.000	E04AA0359	
		5.000			65.000	E04AA0360	
		6.000			70.000	E04AA0361	
	EN TRIANGULAR BASE PLATE	0.300	0.300		6.300	E04AA0362	
DE DREIECKFUßPLATTE							
	EN END ADAPTER FOR TRIANGULAR COLUMNS	0.170	0.170		2.600	E04AA0363	
DE ZENTRIERSTÜCK FÜR DREIGURTSTÜTZEN							
	EN TUBE CONNECTOR WITH HALF-COUPLER				1.800	00470	
DE ROHRVERBINDER MIT HALBKUPPLUNG					1.800	00471	

Ladder and accessories



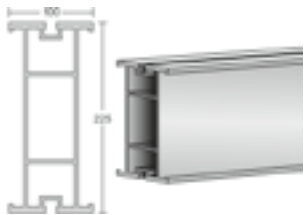

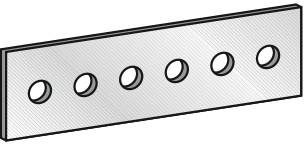
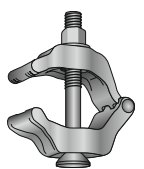
		↑ m	↔ m	↗ m	kg/1	ART	€/1
	EN VERTICAL STEEL LADDER WITH TUBE CONNECTORS	2.000	0.430		16.300	E04RS0454	
		3.000	0.430		23.600	E04RS0455	
	DE STAHLROHR-STEIGELEITER MIT ROHR-VERBINDER	4.000	0.430		38.400	E04RS0456	
	EN VERTICAL ALUMINIUM LADDER WITH TUBE CONNECTORS	2.000	0.470		6.000	E04AA0364	
		3.000	0.470		9.000	E04AA0344	
	DE ALU-STEIGELEITER MIT ROHRVERBINDER	4.000	0.470		11.000	E04AA0345	
		5.000	0.470		14.000	E04AA0346	
		6.000	0.470		16.000	E04AA0347	
	EN DROP PIN				0.100	00396	
	DE FALLSTECKER						
	EN SPACER TUBE COMPLETE WITH FERRULE AND PIN	1.800			6.400	50	E02RS0014
	DE UNTERSETZROHR KOMPLETT MIT MUFFE UND STECKER						
	EN SPARE PARTS FOR SPACER TUBE			Sleeve ferrule, Muffe	0.135		00568
	DE ERSATZTEILE FÜR UNTERSETZROHR			Pin plug, Stecker	0.178		00569
	EN SCAFFOLD CORD	1.500		PP/plastic material, breaking resistance 500 kg			01337
	DE GERÜSTSTRICK			PP/Kunststoff - Reißfestigkeit 500 kg			
		2.000		Sisal/polypropylene, breaking resistance 480 kg			01341
		3.000		Sisal/Polypropylen - Reißfestigkeit 480 kg			01349
	1.800		Sisal/polypropylene, breaking resistance 480 kg			01359	
				Sisal/Polypropylen - Reißfestigkeit 480 kg			

Other designs and lengths upon request



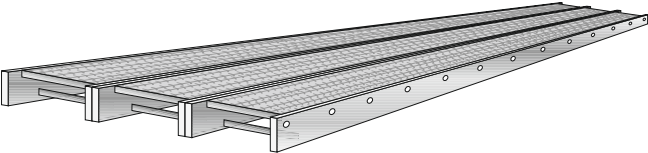

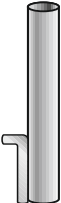
Aluminium beam

		↑ m	↔ m	↗ m	KG/1	ART	€/1
							
	EN ALU-TRÄGER I 160	6.400	0.120		33.900	01004	
		8.000	0.120		42.400	01009	
		11.900	0.120		47.700	01017	
						Larger quantities upon request	
	EN ALUMINIUM BEAM TITAN 225	3.000	0.100		25.500	07124	
DE ALU-TRÄGER TITAN 225		5.000	0.100		42.500	07125	
		7.500	0.100		63.700	07127	
						Larger quantities upon request	
	EN BUTT PLATE FOR ALUMINIUM GIRDER 160	0.600	0.210		11.400	01020	
DE STOßBLASCHE FÜR ALU-TRÄGER 160							
	EN BUTT PLATE FOR TITAN-H BEAM 225	0.600	0.210		16.000	07130	
DE STOßBLASCHE FÜR TITAN-H-TRÄGER 225							
	EN UNIVERSAL BEAM CLAMP FOR BEAMS 16 -70 MM	0.050	0.100		2.200	00087	
DE UNIVERSAL-TRÄGERKLEMME FÜR TRÄGER 16-70 MM							
	EN HOLDING CLAW	0.500	0.250		13.800	E04AA0366	
DE SICHERHEITSTRÄGERKLAUE							
	EN ADAPTER COUPLER	0.500	0.250		9.000	E04AA0367	
DE ADAPTERKUPPLUNG							

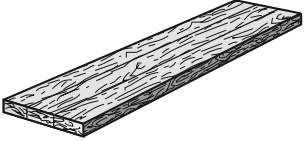
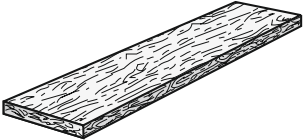

Aluminium planks

	↑ m	↔ m	↗ m	kg/1	ART	€/1
 <p>EN ALUMINIUM GANGWAY DE ALU-STEG</p>	4.120	0.570	2.0kN	23.000	00987	
	5.200	0.570	2.0kN	30.000	00988	
	6.000	0.570	2.0kN	35.000	00989	
	8.000	0.570	2.0kN	59.000	00990	
	10.200	0.570	1.5kN	72.000	00991	
 <p>EN RAILING HOLDER FOR ALUMINIUM PLANKS DE GELÄNDERHALTER FÜR ALU-STEG</p>				2.800 3.400	00404 00407	
 <p>EN RAILING HOLDER OPPOSITE HAND FOR ALUMINIUM PLANKS DE GELÄNDERHALTER-GEGENSTÜCK FÜR ALU-STEG</p>				1.400	00408	
 <p>EN TILT LOCK DE KIPPSICHERUNG</p>				1.000 1.000	00401 00402	



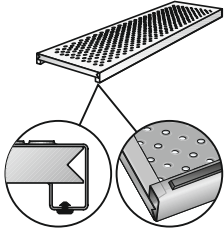
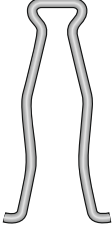

Timber planks

		↑ m	↔ m	↖ m	KG/1	ART	€/1
	EN	SPECIAL BONDED PLANK, RED IMP-REGNATED	1.000	0.240	6.000	01096	
			1.500	0.240	9.000	01097	
	DE	SPEZIAL-GERÜSTBOHLE, VERLEIMT, ROT IMPRÄGNIERT	2.000	0.240	12.000	01098	
			2.500	0.240	15.000	01099	
			3.000	0.240	18.000	E04AA0452	
			3.500	0.240	21.000	01101	
			4.000	0.240	24.000	01102	
	EN	WOODEN PLANK	1.000	0.240	6.000	01075	
	DE	GERÜSTBOHLE	1.500	0.240	9.000	01075	
			2.000	0.240	12.000	01080	
			2.500	0.240	15.000	01082	
			3.000	0.240	18.000	01083	
			3.500	0.240	21.000	01086	
			4.000	0.240	24.000	01090	
			4.500	0.240	27.000	01094	
			5.000	0.240	30.000	01095	
			1.000	0.280	7.000	01106	
		1.500	0.280	10.500	01107		
		2.000	0.280	14.000	01109		
		2.500	0.280	17.500	01111		
		3.000	0.280	21.000	01112		
		3.500	0.280	24.500	01114		
		4.000	0.280	28.000	01115		
		4.500	0.280	31.500	01116		
		5.000	0.280	35.000	01117		
Special prices for larger quantities upon request!							
	EN	SURCHARGE FOR HOOPED PLANKS, PER PLANK			With corrugated iron hoop mit Wellenbandeisen beschlagen	01069	
	DE	AUFPREIS FÜR BESCHLAGENE GERÜSTBOHLEN, PRO BOHLE			Cornered with galvanized iron hoops, incl. embossed name geeckt und mit verzinktem Bandeisen beschlagen, einschl. Namensprägung	E04AA0453	
	EN	IRON HOOP FOR SCAFFOLDING PLANKS	0.500	0.030	11.000	00757	
			0.600	0.030	12.000	00759	
	EN	IRON HOOP FOR SCAFFOLDING PLANKS WITH NAME EMBOSSING	0.758	0.030	11.000	00758	
	DE	BANDEISEN FÜR GERÜSTBOHLEN MIT NAMENSPRÄGUNG	0.600	0.030	12.000	00760	
	EN	CORRUGATED IRON HOOP	0.018	0.001	6.800	00761	
	DE	WELLENBANDEISEN					

Timber planks



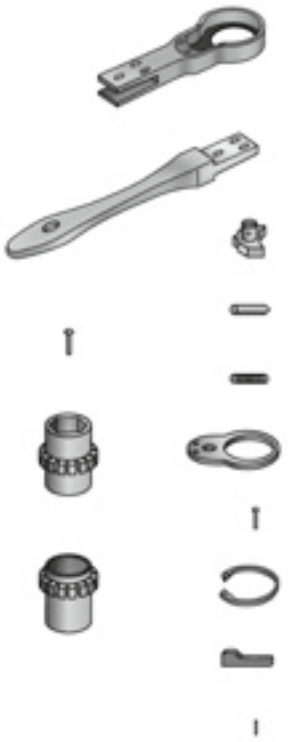

		↑ m	↔ m	↗ m	kg/1	ART	€/1
	EN	STEEL PLANK, NON-SYSTEM					
	DE	STAHLBOHLE - SYSTEMFREI					
		1.000	0.190		6.700	05622	
		1.500	0.190		9.100	05623	
		2.000	0.190		11.900	05624	
		2.500	0.190		13.600	05625	
		3.000	0.190		16.300	05636	
		1.000	0.260		6.700	E04AA0175	
		1.500	0.260		9.100	E04AA0235	
		2.000	0.260		11.400	E04AA0236	
		2.500	0.260		13.600	E04AA0237	
		3.000	0.260		18.200	E04AA0240	
		1.000	0.300		6.900	E04AA0241	
		1.500	0.300		9.300	E04AA0242	
		2.000	0.300		11.700	E04AA0243	
	2.500	0.300		14.100	E04AA0244		
	3.000	0.300		16.300	05606		
	EN	LOCKING SPRING FOR NON-SYSTEM STEEL PLANKS					
	DE	SICHERUNGSFEDER FÜR SYSTEMFREIE STAHLBOHLE					
		0.060	0.010		0.010	E04AA0237	
	EN	TOE BOARD CLAMP					
	DE	BORDBRETTKLAMMER					
					0.100	E04AA0326	

Ratchet spanner and work aids



		↕ m	↔ m	↗ m	KG/1	ART	€/1
	EN RATCHET SPANNER - MANNESMANN RATCHET	SW 19			0.800	00321	
	DE RATSCHENSCHLÜSSEL -MANNESMANN-RATSCHEN (ERSATZTEILFÄHIG)	SW 22			0.800	E04AA0421	
	EN DOUBLE RATCHET SPANNER - MANNESMANN RATCHET	SW 19 / 22			0.900	E04AA0369	
	DE DOPPELRATSCHENSCHLÜSSEL -MANNESMANNRATSCHEN (ERSATZTEILFÄHIG)	SW 22 / 24			0.900	00328	
	EN DOUBLE RATCHET SPANNER ROBUST	SW 19 / 22			0.900	E04AA0331	
DE DOPPELRATSCHEN - ROBUSTE AUSFÜHRUNG							
	EN DOUBLE RATCHET SPANNER LIGHT	SW 19 / 22			0.400	E04AA0422	
DE DOPPELRATSCHEN - LEICHTE AUSFÜHRUNG							
	EN SPARE PARTS FOR RATCHET SPANNER				Double ratchet wheel SW 19 + 22	00329	
	DE ERSATZTEILE FÜR RATSCHENSCHLÜSSEL				Doppel-Sperrad SW 19 + 22		
					Double ratchet wheel SW 22 + 24	00331	
					Doppel-Sperrad SW 22 + 24		
					Ratchet wheel SW 19, Sperrrad SW 19	00332	
					Ratchet wheel SW 22, Sperrrad SW 22	00333	
					Catch, Sperrstück	00335	
					Cover, Deckel	00336	
					Locking pin, Sperrstift	00337	
					Change lever, Umschalthebel	00338	
					Snap ring for cover, Seegering für Deckel	00339	
					Half round rivet for handle 5 x 25 mm DIN 660	00340	
					Halbrundniete für Griff 5 x 25 mm DIN 660		
					Half round rivet for cover 2.5 x 20 mm DIN 660	00341	
				Halbrundniete für Deckel 2,5 x 20 mm DIN 660			
				Pressure spring for locking pin Druckfeder für Sperrstift	00342		
				Pin for change lever 2 x 12 mm Stift für Umschalthebel 2 x 12 mm	00343		
				Housing, Gehäuse	00344		
				Aluminium handle, Alu-Griff	00345		

Special prices for larger quantities upon request



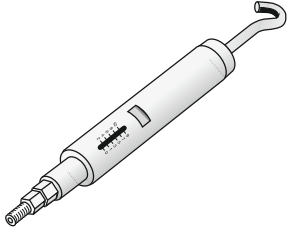
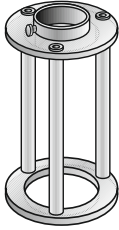
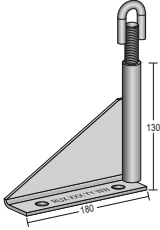
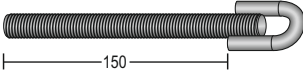

Ratchet spanner and work aids

		↑ m	↔ m	↗ m	kg/1	ART	€/1
	EN STABILA SPIRIT LEVEL WITH MAGNET DE STABILA WASSERWAAGE MIT MAGNET	0.250			0.200	E04AA0343	
	EN RATCHET SPANNER BELT DE RATSCHENGÜRTEL	1.200			0.100	E04AA0340	
	EN SNAP HOOK DE RATSCHENHALTER	0.070				A04AA0341	
	EN RATCHET SPANNER HOLSTER DE KARABINERHAKEN	0.120			0.180	E04AA0341	





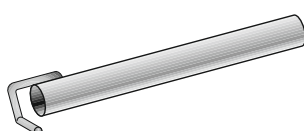

Mounting material

		↑ m	↔ m	↖ m	KG/1	ART	€/1
	EN TIE TESTER DE VERANKERUNGSPRÜFGERÄT	0.545	0.050		1.800	E04AA0385	
	EN SUPPORT CYLINDER DE STÜTZZYLINDER	0.235	0.100		1.800	E04AA0385	
	EN STAINLESS M 16 PERMANENT ANCHOR DE VA-PERMANENTANKER M16 EDELSTAHL	0.130	0.180		0.650	07060	
	EN M16 EYE BOLT DE AUGENSCHRAUBE M16	0.150			0.300	07061	
	EN PU PLUG DE PU-STOPFEN	0.030				07062	
	EN PE PLATE, SELF-ADHESIVE DE PE-PLATTE - SELBSTKLEBEND	0.150	0.030			00375	

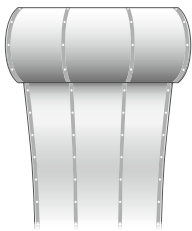

Mounting material

		↕ m	↔ m	↗ m	kg/1	ART	€/1
	EN EYE BOLT	0.090	0.012		0.155	E04AA0355	
	DE RINGSCHRAUBE	0.120	0.012		0.155	E04AA0287	
		0.160	0.012		0.155	E04AA0187	
		0.190	0.012		0.155	00293	
		0.230	0.012		0.155	E04AA0370	
		0.300	0.012		0.155	E04AA0371	
		0.350	0.012		0.155	E04AA0261	
	EN CAP FOR RAWL PLUGS, WHITE TRANSPARENT	0.040	0.029			01179	
	DE KREUZLAMELLE WEIB-TRANSPARENT	0.050	0.025			E04AA0384	
		0.080	0.029			01212	
		0.120	0.030			01201	
Further colours and dimensions on request.							
	EN CAP						
	DE ABDECKKAPPE						
	white-transparent, weiß-transparent grey, grau black, schwarz	0.040			0.186	01178	
		0.040			0.186	01180	
		0.040			0.186	01194	
Further colours and dimensions on request.							
	EN NYLON RAWL PLUG	0.070	0.014		1.400	E04AA0432	
	DE NYLONDÜBEL	0.100	0.014		2.500	E04AA0288	
		0.135	0.014		2.500	05238	
		0.185	0.014		2.500	05239	
Other sizes upon request							
	EN STEEL SHORE TUBE	0.300			1.400	E04AA0277	
	DE STAHLROHRABSTEIFER	0.400			1.800	E04AA0278	
		0.600			2.500	E04AA0279	
		1.000			4.000	E04AA0280	
		1.400			5.400	E04AA0281	



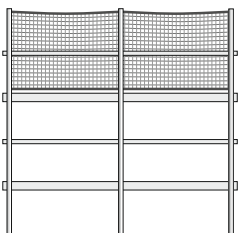

Tarpaulins, nets and keder systems

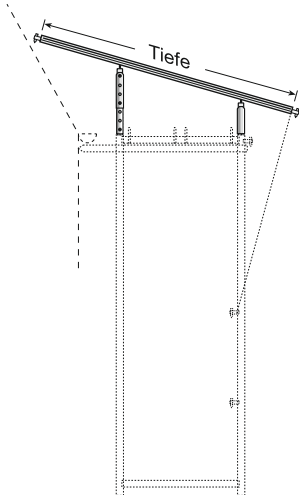
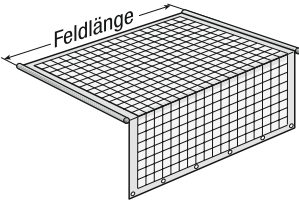
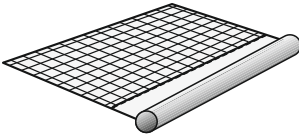
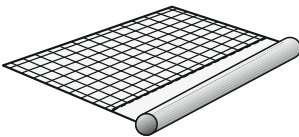
		↑ m	↔ m	↖ m	KG/1	ART	€/1
	EN TARPULIN MESH FABRIC 200 DE GERÜSTPLANE GITTERGEWEBE 200	20.000 20.000	2.700 3.200			E04AA0372 E04AA0373	
							corresponds to price of/m²: 0.89 / 0.79 / 0.74
	EN TARPULIN MESH FABRIC 150 DE GERÜSTPLANE GITTERGEWEBE 150	20.000 20.000	2.700 3.200			01277 01279	
							entspricht Preis/m²: 0,62 / 0,59 / 0,56
	EN TARPULIN, BAND FABRIC 150 DE GERÜSTPLANE BÄNDCHENGEWEBE 150	20.000 20.000	2.600 3.100			04564 04565	
							corresponds to price of/m²: 0.57 / 0.55
	EN SCAFFOLDING NET 50 DE GERÜSTSCHUTZNETZ 50	20.000 20.000 20.000	2.570 2.570 3.070		green, grün blue, blau green, grün	01244 01246 01247	
							corresponds to price of/m²: 0.36 / 0.32
	EN DELTA-TOGGLE STRAP DE DELTA-KNEBELBINDER					01255	
	EN EXPENDABLE FASTENER, SIMPLE DE EINMALVERBINDER - STANDARD	0.030	0.005		0.220	E04AA0259	
	EN EXPENDABLE FASTENER, REINFORCED DE EINMALVERBINDER - VERSTÄRKT	0.034	0.008		0.420	01258	



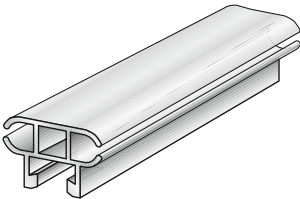

Tarpaulins, nets and keder systems

		↑ m	↔ m	↗ m	kg/1	ART	€/1
	EN	5.000	2.000			01317	
	DE	10.000	2.000			01319	
						Other nets, e.g. safety nets for protection of individuals, upon request corresponds to price of/m²: 2.48 / 2.16	
	EN	0.600				01325	
	DE						
	EN		1.800		4.000	E04AA0378	
	DE						
	EN	1.500	2.600			E04AA0374	
		2.000	2.600			E04AA0375	
	DE	2.500	2.600			E04AA0376	
		3.000	2.600			E04AA0377	
	EN	10.100	2.070			01422	
		10.100	2.000			01426	
	DE	10.100	2.500			01433	
		10.100	3.000			01439	
		10.100	2.570			01444	
		10.100	3.070			01445	
		Deviating lengths upon request. Customized cutting to length to suit individual building sites possible at short notice.					
	EN	10.100	2.500			01280	
		10.100	2.000			01291	
	DE	10.100	2.070			01292	
		8.100	2.500			01296	
		10.100	2.570			01297	
		10.100	3.000			01298	
		10.100	3.070			01299	

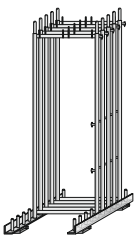
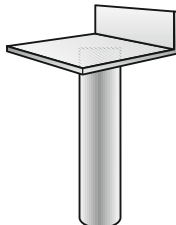

Tarpaulins, nets and keder systems

		↕ m	↔ m	↗ m	KG/1	ART	€/1
	EN KEDER RAIL	1.000			1.500	01449	
	DE KEDERSCHIENE	2.000			3.000	01454	
		3.000			4.500	01456	
		4.000			6.000	01458	
		5.000			7.500	04717	
		6.000			9.000	01459	
	EN KEDER COUPLING	SW 19			1.200	01309	
	DE KEDERKUPPLUNG	SW 22			1.200	01310	
	EN RIDGE KEDER RAIL	1.000			1.500	01450	
DE FIRSTKEDERSCHIENE							
	EN EAVES KEDER RAIL	1.000			1.500	01451	
DE TRAUFKEDERSCHIENE							
	EN FLEXIBLE KEDER RAIL	1.000			1.500	01452	
DE KEDERSCHIENE FLEXIBEL							

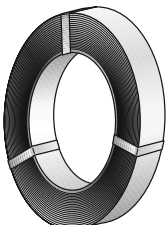
Pallets and storage

		↑ m	↔ m	↖ m	kg/1	ART	€/1
	EN STACKER GRID FOR ALL SCAFFOLDING SYSTEMS DE STAPELTRAVERSE FÜR ALLE GERÜST-SYSTEME	1.570	0.100		16.800	01533	
	EN SLIP-ON ADAPTER DE AUFSETZPROFIL				1.500	01534	
We will be pleased to find special solutions for your individual storing problems!							
	EN BUNDLING PALLET WITH CROSS BASE DE BÜNDELUNGSPALETTE MIT KREUZFUß				9.400	05280	
	EN STEEL STRIP SHEARING MACHINE DE UMFENGERÄT				4.900	E04AA0337	
	EN DECOILING TROLLEY WITH STORAGE BOX DE ABROLLWAGEN MIT ABLAGEKASTEN				31.000	E04AA0338	
	EN STEEL STRIP COIL FOR PACKAGING DE VERPACKUNGSSTAHLBAND				42.000	E04AA0339	

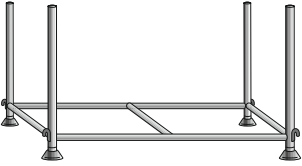
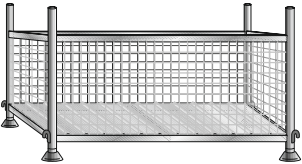
Pallets and storage

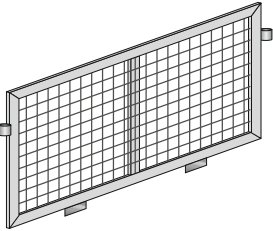
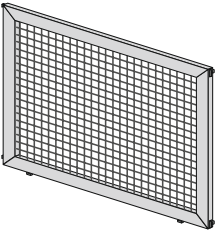
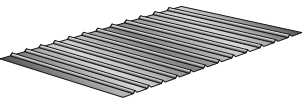
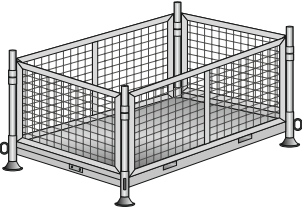



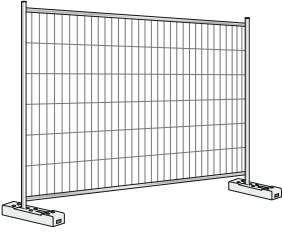
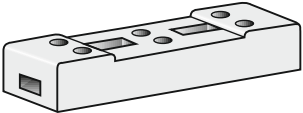
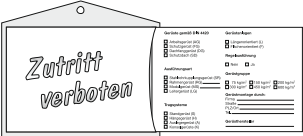
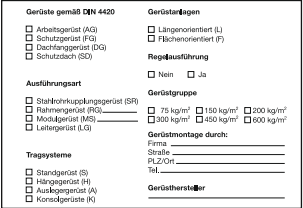
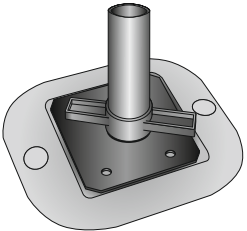
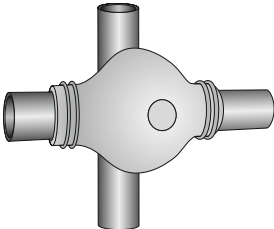
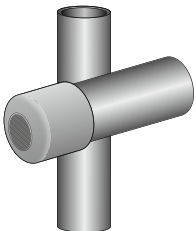

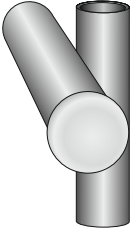
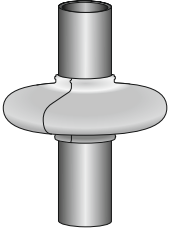
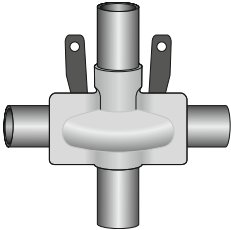
		↑ m	↔ m	↖ m	KG/1	ART	€/1
	EN STACKING PALLET DE STAPELPALETTE	1.300	0.700		34.000	03165	
	EN WIRE MESH BOX PALLET DE GITTERBOXPALETTE	1.300	0.700		65.000	03178	
	EN DURALOK STACKING RACK, DISMOUNTABLE DE STAPELGESTELL DURALOK, ZERLEGBAR	1.250	0.850		45.600	E08SR0032	
	EN CENTRE FRAME DE MITTEL-EINSTECKRAHMEN		0.850			E08SR0034	
	EN DURALOK WIRE MESH SIDE PANEL DE SEITEN- UND QUERGITTER DURALOK	1.250 0.850		side railing Traverse railing	12.500 8.500	E08SR0035 E08SR0036	
	EN DURALOK CENTRAL PANEL DE MITTELGITTER DURALOK		0.800			E08SR0037	
	EN DURALOK BASE PANEL DE BODENPLATTE DURALOK	1.250	0.850		105.500	E08SR0038	
	EN DURALOK WIRE MESH BOX, COMPLETE DE GITTERBOX DURALOK, KOMPLETT	1.250	0.850		105.500	E08SR0033	





Site safety equipment

			↑ m	↔ m	↗ m	kg/1	ART	€/1
	EN SITE FENCE ROBUST DE BAUZAUN ROBUST		3.500	2.000		22.700	00806 00809	
		Coupling element						
	EN CONCRETE BALLAST WEIGHT DE BETON-BALASTGEWICHT		0.710	0.230		36.000	00808	
	EN SCAFFOLD SIGN DE GERÜSTSCHILD		0.210	0.200			01411	
	EN FORM BLOCK DE FORMULAR-BLOCK						01412	
	EN SUPPORT PAD FOR THREADED BASE PLATE DE UNTERLAGE FÜR GEWINDEFÜßPLATTE						E04AA0393	
	EN PROTECTIVE CAP FOR COUPLING CONNECTIONS DE SCHUTZKAPPE FÜR KUPPLUNGSVERBINDUNGEN						E04AA0392	
	EN PROTECTIVE TUBE END CAP DE SCHUTZKAPPE FÜR ROHRENDEN						E04AA0396 E04AA0397	
		for longitudinal tubes, für längsseitige Rohre						

		↕ m	↔ m	↗ m	KG/1	ART	€/1
	<p>EN PROTECTIVE TUBE END CAP WITHOUT REFLECTOR</p> <p>DE SCHUTZKAPPE FÜR ROHRENDEN OHNE REFLEKTOR</p>					E04AA0455	
	<p>EN PROTECTIVE CAP SET FOR STANDARD FLANGE - COMPLETE</p> <p>DE SCHUTZKAPPE FÜR STÄNDERTELLER - KOMPLETT</p>					E04AA0394	
	<p>EN PROTECTIVE CAP FOR STANDARD FLANGE</p> <p>DE SCHUTZKAPPE FÜR STÄNDERTELLER</p>					E04AA0395	

Work safety

		↑ m	↔ m	↗ m	kg/1	ART	€/1
	EN PREMIUM SET DE PREMIUM-SET					06120 E04AA0333	
	EN SAFETY HARNESS REVOLUTION R2 DE AUFFANGGURT REVOLUTION R2					06123 06124	
	EN MANYARD FASTENER WITH SHOCK ABSORBER DE MANYARD VERBINDUNGSMITTEL MIT BANDFALLDÄMPFER	2.000				06126	
	EN AGU30 SAFETY HARNESS DE AUFFANGGURT AGU30					06125	
	EN FASTENER WITH SHOCK ABSORBER DE VERBINDUNGSMITTEL MIT BANDFALLDÄMPFER					06130	
	EN VERBINDUNGSMITTEL MIT BANDFALLDÄMPFER DE VERBINDUNGSMITTEL MIT BANDFALLDÄMPFER	2.000				06128	

	⇅ m	↔ m	↗ m	KG/1	ART	€/1
 <p>EN STANDARD SET DE STANDARD-SET</p>					06122	
 <p>EN SCORPION FALL ARRESTER DE SCORPION FALLBEGRENZER</p>	2.700				06127	
<p>EN TOOL BAG (WITHOUT ILLUSTRATION) DE WERKZEUGTASCHE (OHNE ABBILDUNG)</p>					06129	
 <p>EN IKAR HWPS 18 FALL PROTECTION DEVICE DE IKAR-HÖHENSICHERUNGSGERÄT HWPS 18</p>					06180	<p>Safety device for horizontal and vertical use. Working length 15 metres, steel cable tested for sharp edges. Sicherungsgerät für horizontalen und vertikalen Einsatz. 15 Meter Nutzlänge, scharfkanten getestetes Stahlseil.</p>
 <p>EN IKAR RESCUE SET ABS 3 WH DE IKAR-RETTUNGS-SET ABS 3 WH</p>	20.000			6.200	06184	
	40.000			6.200	06185	
	20.000	without telescopic bar o. Teleskopstange		5.690	06186	
	40.000	without telescopic bar o. Teleskopstange		5.690	06187	
 <p>EN MILLER HELMET DE HELM - MILLER</p>					06134	



48 mm

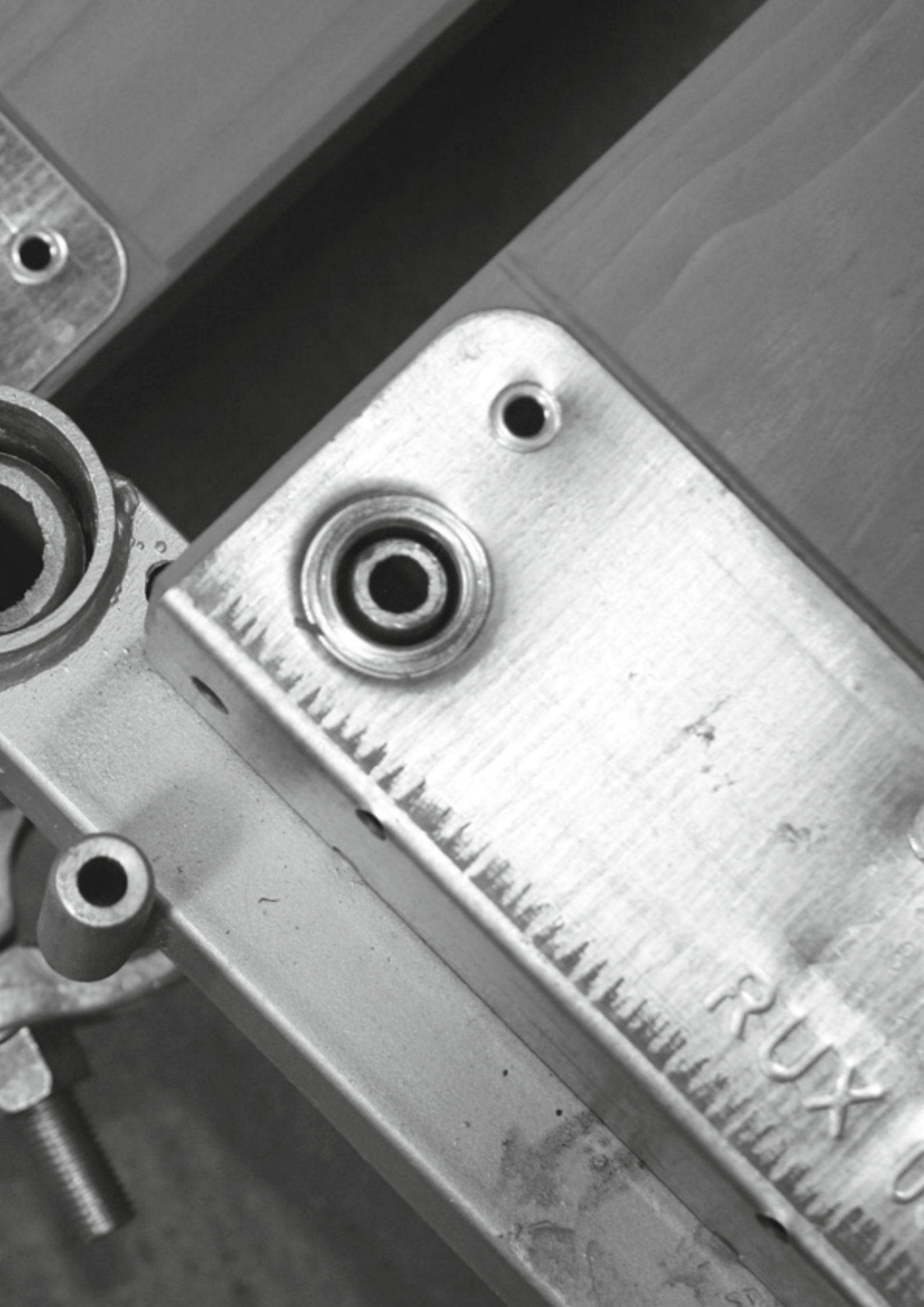

Scafom-rux International

De Kempen 5
6021 PZ Budel
Netherlands
P +31 495 497204
F +31 495 430676
info@scafom-rux.com

Scafom-rux has a significant business presence in the following countries:

Belgium, Canada, Chile, China, Czech Republic, Germany, France, Great Britain, Hong Kong, Netherlands, Peru, Poland, Portugal, Romania, Spain, Turkey and the USA.



www.scafom-rux.com

Product Assortment Non-system **ACCESSORIES** Subject to change without notice. Errors and omissions excepted.

 **scafom-rux**
international